

1. Beispiel

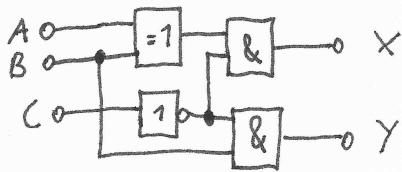

1. Wahrheitstabelle
2. KV-Diagramm
3. disjunktive Normalform
4. Realisierung mittels PLA

2. Beispiel

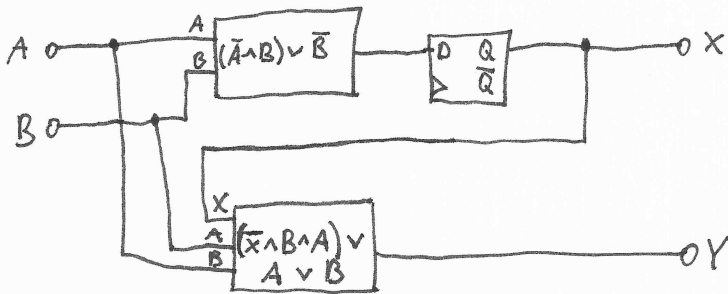

Realisierung mittels GAL

1. Beispiel

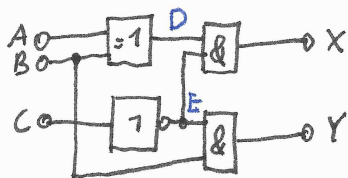

D & E sind Hilfsvariablen für Zwischenschritte

1. Wahrheitstabelle

A	B	C	X	Y	D	E
0	0	0	0	0	0	1
0	0	1	0	0	0	0
0	1	0	1	1	1	1
0	1	1	0	0	1	0
1	0	0	1	0	1	1
1	0	1	0	0	1	0
1	1	0	0	1	0	1
1	1	1	0	0	0	0

2. KV-Diagramm

X

A \ BC	BC			
	00	01	11	10
0	0	0	0	1
1	1	0	0	0

Y

A \ BC	BC			
	00	01	11	10
0	0	0	0	1
1	0	0	0	1

3. DNF

$$X = A\bar{B}\bar{C} \vee \bar{A}B\bar{C}$$

$$Y = B\bar{C}$$

1. Beispiel

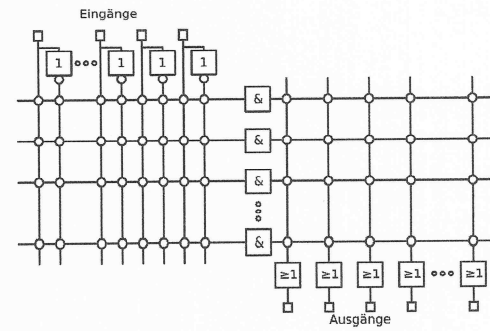
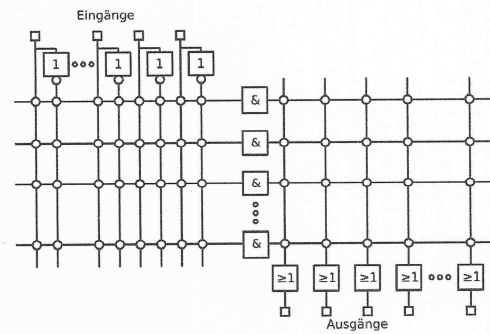
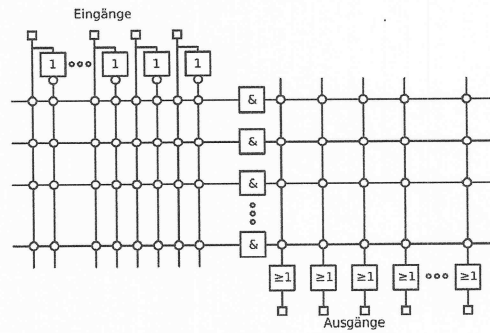
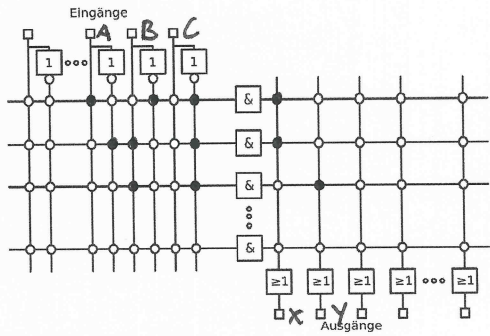

2. Beispiel

